



NATIONAL RESEARCH CENTRE
"KURCHATOV INSTITUTE"



Fusion-Fission Hybrid Systems and Molten Salt Technologies in Large-Scale Nuclear Energy

E. Velikhov

e-mail: velikhov@mac.com

Primary energy consumption scenarios in the XXI century

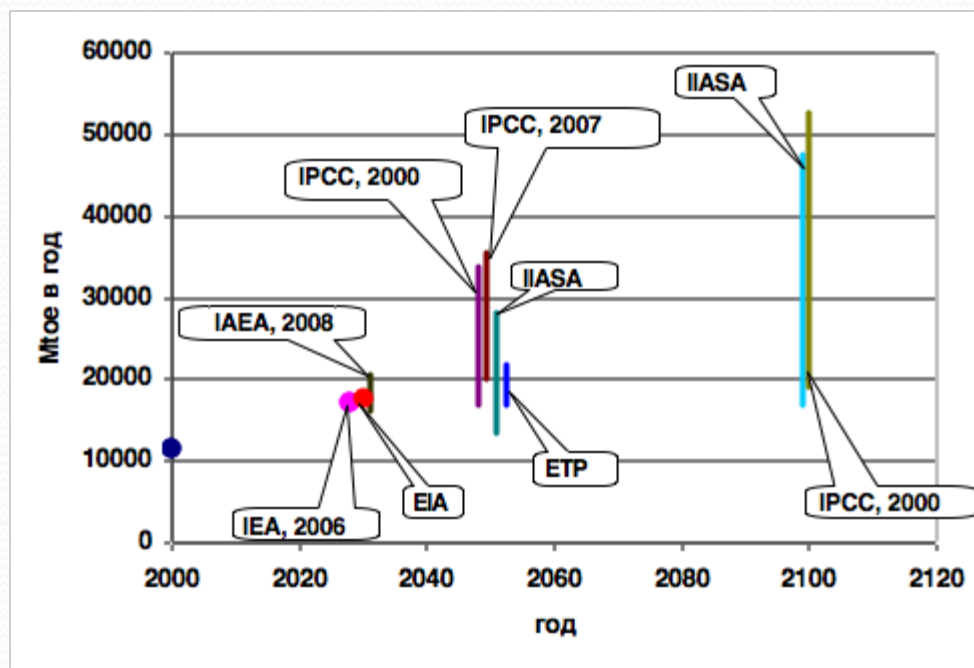

International organizations IAEA, IAE, IPCC, IIASA have developed energy consumption scenarios in the world in the XXI century. According to the estimates, the needs should increase from 10 GTFOE (Gigatons of fuel oil equivalent) in 2000 to 15-35 GTFOE in 2050 and 20-50 GTFOE in 2100.

Global Energy Demands and Supply Opportunities of Energy Sources

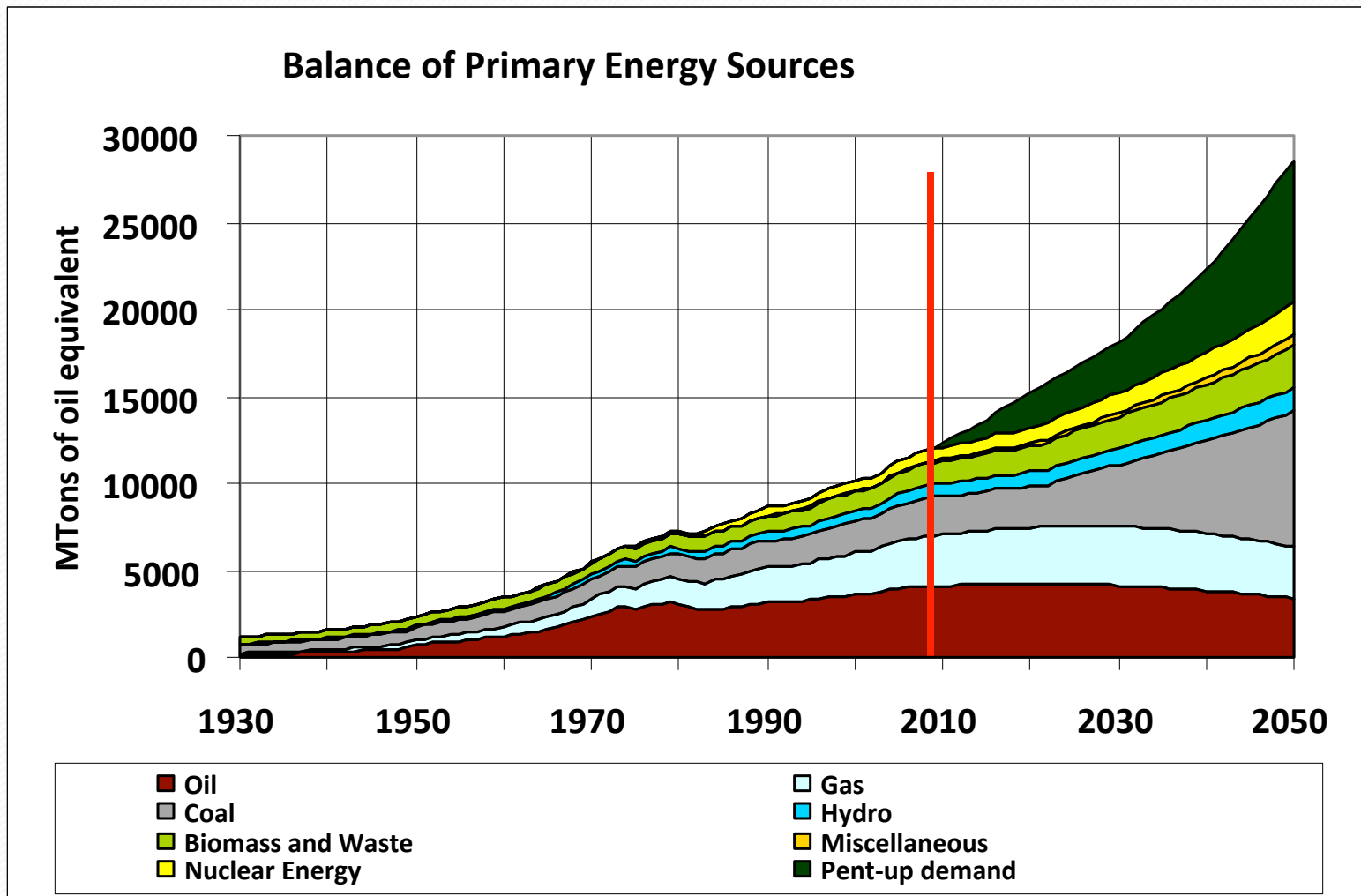

- 
- **Fission and Fusion nuclear power** is the unique energy source with almost unlimited resources that is free of carbon dioxide emissions and is capable to decrease the negative impact on environment.



Nuclear power should solve the number of critical problems. Without its decision could not occupy the adequate place in the world energy fully correspond their unique potential.



These problems are follows:

- Full nuclear and radioactivity environment safety, protecting from possibilities to repeat the accident as Chernobyl, Fukushima or Three Mile Island with the pollution of radioactivity in levels threatening population and environment, as could say the “Green” fission energy.
- Maximum usage of the fuel energy potential by increasing of the burn up level of nuclear fuel and using closed fuel cycle.
- The utilization of nuclear waste which make easy the decision of burying or using at power station and centralized processing and transmutation minor actinides.
- To create the harmonized structure of nuclear energy from extraction of raw materials and using it in all type of fission reactors, including hybrid devices as “green” nuclear energy to minimize nuclear waste during process of preparation fuel, to utilization long term nuclear waste.



The fusion neutrons, using in hybrid reactors, having more less energy cost and it will allow, in perspective, to realize the fuel cycle with least radioactivity using molten salt fuel not only in a blankets, but also in active zone of reactors under unbroken process extraction of fission products.

To include hybrid reactors in harmonized structure of nuclear energy allows to minimize it's potential dangers and get necessary fuel resources under acceptable economy.

Necessary innovative technologies for nuclear power development until 2050

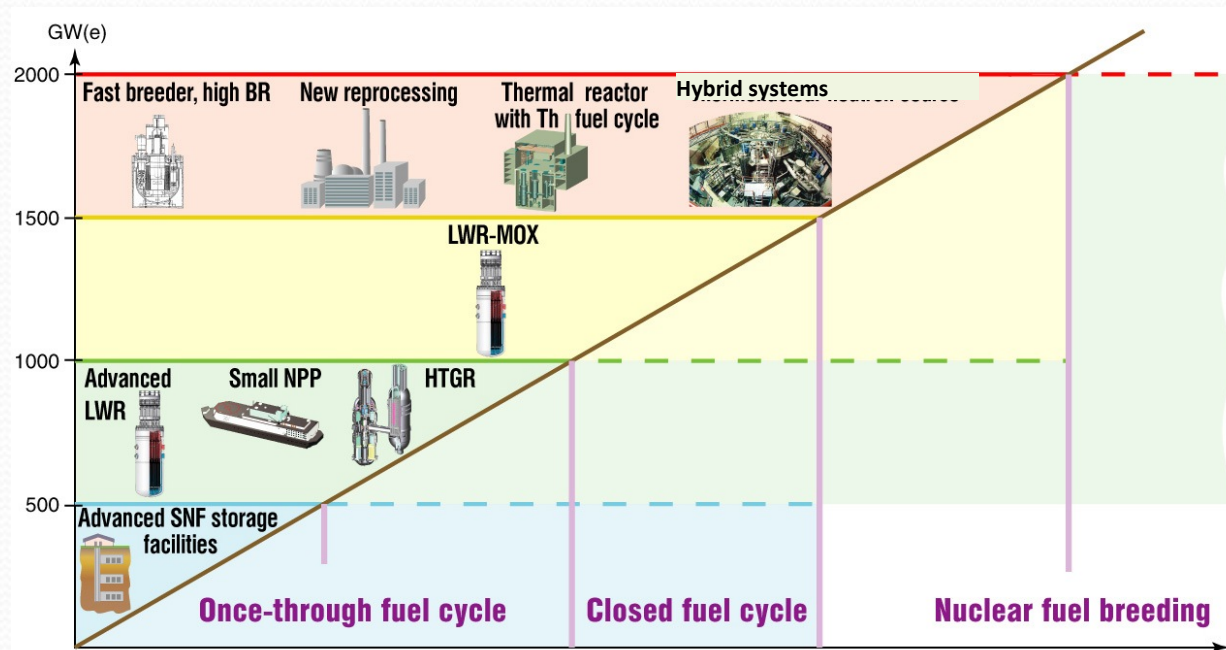

The development of nuclear power industry in accordance with social requirements is possible only on the innovative technologies basis.

IAEA Nuclear Energy Series No NP-T-1.8 Nuclear Energy Development in 21-st Century: Global scenarios and regional trends. 2010, Vienna, Austria.

The scenarios of innovative development of nuclear power industry in Russia are based on the all kind Russian fuel resource

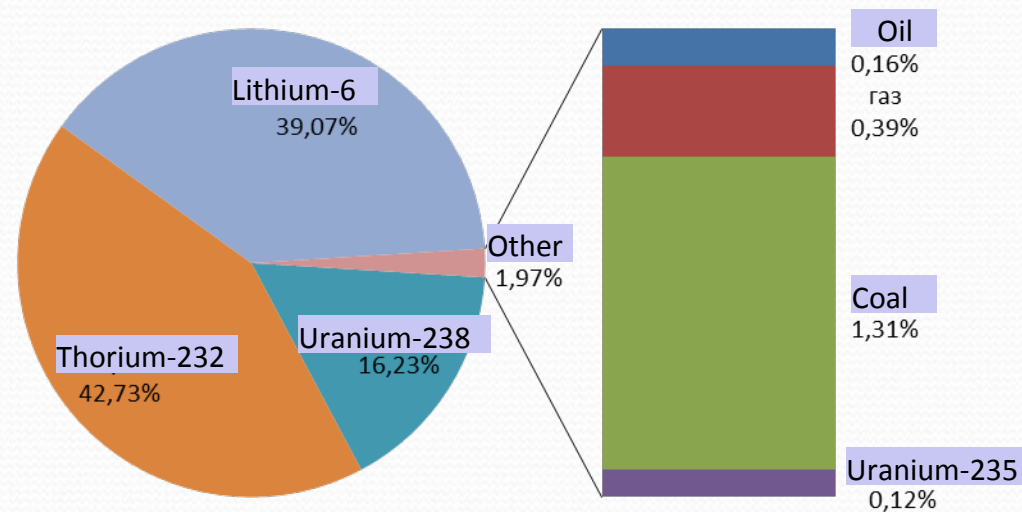

Oil – $12 \cdot 10^9$ t, Gas - $44 \cdot 10^{12}$ m³, Coal - $1.57 \cdot 10^{11}$ t, Unat – $6 \cdot 10^5$ t

Main energy sources are U238, Li and Th232

- 
- **Nuclear Energy in Russia based on fission reactors is developed in frames of national programs**
 - **Fusion Energy is developed within a wide international collaboration like ITER. ITER is being constructed in France. Next step - DEMO program was started under auspices of IAEA**
 - **Construction of the first Commercial Fusion Power Plant is planned by 2050**

- 
- Fusion Fission Hybrid Systems are considered in world Fusion and Fission communities (meetings in USA, Russia, China, India; conferences of IAEA, APS, APS)
 - Igor Kurchatov had pointed out on the possibility to use fusion neutrons of nuclear fuel breeding (Pu, U233, T) in his historic letter to the USSR Government in January 1951
 - Hybrid systems for nuclear fuel breeding and incineration of long life isotopes have been intensively discussed in USA and USSR in during 70-ies of XX century. Results have been summaries in proceedings of the joint seminar at Kurchatov Institute, Moscow in 1976

First Russian design of a hybrid reactor under

E. Velikhov and I. Golovin leadership was developed in 1977

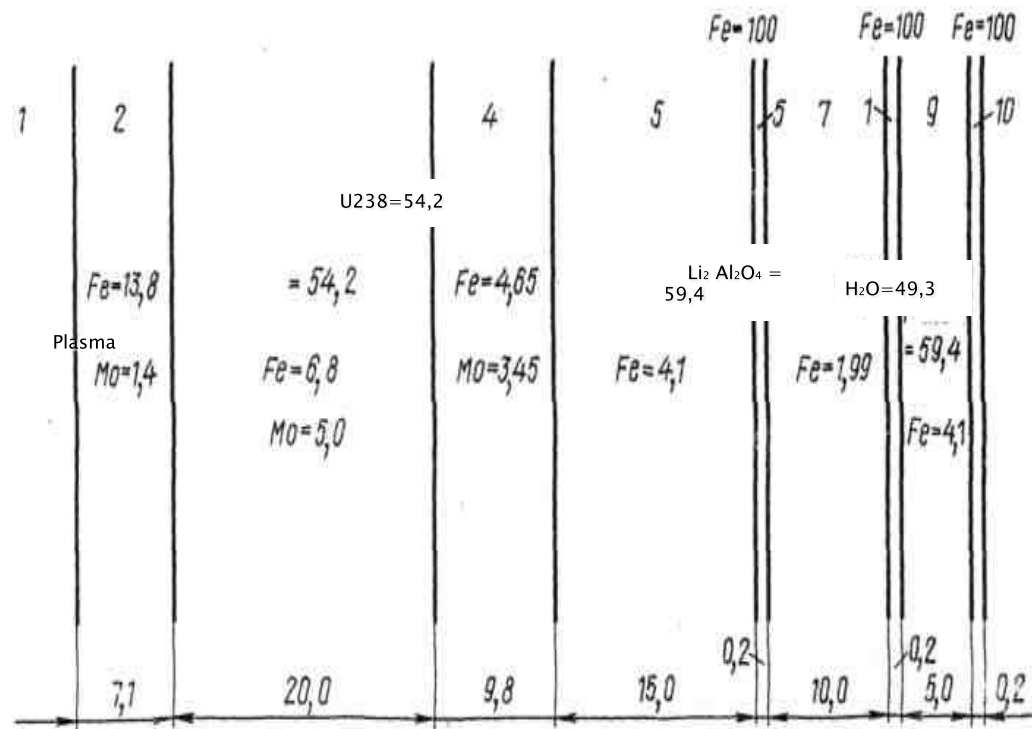

Hybrid tokamak design parameters

$a=1.5$ m, $R=6.4$ m, $K=2$,
 $I_p=3.8$ MA, $B_t=6$ T,
 $P_{NBI}=200 \times 8=1600$ MW,
 $E_{NB}=500$ keV
 $P_{fus} \approx 600$ MW
 Hybrid

$S=633\text{m}^2$,
 $V=575\text{m}^3$

Blanket schematic diagram
 Dimensions are in cm
 The shield width is 70 cm

Li₂Al₂O₄

Nuclear design parameters of the Hybrid reactor (1977)

Average thermal power, MW	6905
Electric power, MW	2500
Blanket charge of U-238, ton	1110
Irradiation time interval, year	2.65
Plutonium breeding rate, kg/y	4200
Build-up of Pu in Uranium by the end of the campaign, kg/ton	10
Tritium consumption, kg/y	37.2
Tritium breeding in blanket kg/y	38.7
Lithium mass, ton	160
Blanket area, m ²	545
Lithium containing blanket area, m ²	41
Thickness of blanket and shield, m	1.4
Tritium breeding ratio	1.04
Average 14 MeV neutron flux, 1/cm ²	4.6*10 ¹³



Opportunities of Hybrid Systems are considered in Russia in the following aspects:

-development of Green Nuclear Power on the basis of molten salt fuels and technologies of continuous processing the fission products. This approach simultaneously escapes heavy reactivity accidents and accidents with loss of heat transfer

-breeding of U233 from Thorium in a molten salt blanket with suppressed fission with low radioactivity

-Minor Actinides transmutation and auxiliary electricity generation using molten salt technologies

-High temperature energy generation in subcritical active core with Th-U fuel cycle

development and testing plasmophysical, electrophysical, nuclear technologies and materials needed for DEMO project

Max scenario for fission energy development with Hybrids

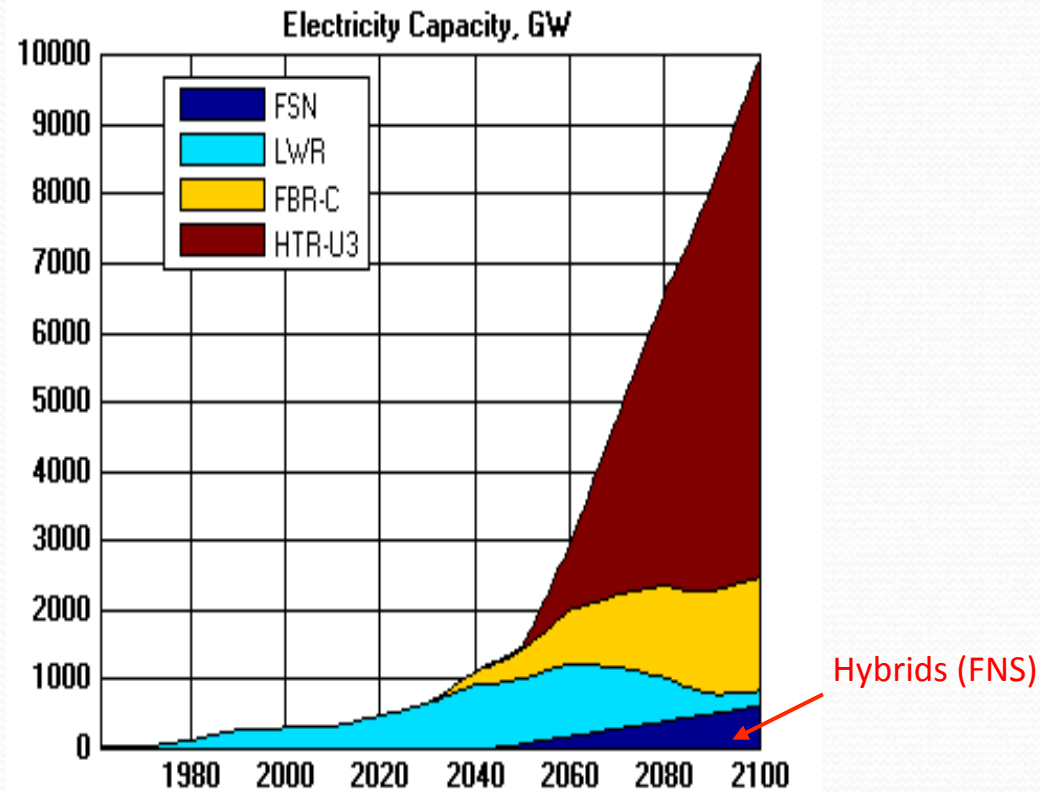

*IAEA Nuclear Energy Series No NP-T-1.8
Nuclear Energy Development in 21-st Century:
Global scenarios and regional trends.
2010, Vienna, Austria.*

- 
- Important consequence of hybrid technologies implementation should become a substantial reduction of radiotoxicity generated in nuclear fuel cycle and the contamination level produced by the fuel processing
 - This problem becomes most significant if a closed nuclear fuel cycle will be adopted
 - These crucial issues of hybrid systems and technologies laid in the project of the Pilot Hybrid Plant that is aimed at construction of the device by 2030

Tokamak will be the fusion part of Hybrid reactor

TOKAMAKS:

- Have a possibility to create steady state neutron sources with the yield of 10^{16} - 10^{20} n/s
- have a high potential for development while other competitors are close to technical limits
- have already demonstrated the seconds of generation
 $5 \cdot 10^{18}$ n/s with neutron energy 14.1 MeV in DT reaction and
 $5 \cdot 10^{16}$ n/s with neutron energy 2.5 MeV in DD reaction



Milestones of Hybrid Program

Design and upgrade of T-15 tokamak and other RF test beds and facilities as physical prototypes of Fusion Neutron Source FNS

Development of DEMO-FNS and design of Pilot Hybrid Plant (PHP) for transmutations, tritium and fissile isotopes breeding

Design, construction and transfer of Hybrid Reactors for fuel breeding and transmutations and Fusion Neutron Sources for research and innovative neutron technologies to Nuclear Industry, Science and Technology

Concept of tokamak based Fusion Neuron Source

- Aspect ratio about 2.5
- Moderate size and elongation
- Fusion/Heating power amplification factor $Q \sim 1$
- D-T fusion power < 100 MW
- H-factor in ITER scaling for energy confinement 1,2-1.4
- Neutral beam energy < 500 keV
- Inductive and non-inductive of current ramp-up and current drive
- Kinetic control in steady state operation mode

Feasibility of Pilot Hybrid Reactor by 2030

1. Regimes with $Q \sim 1$ are realized in tokamaks
2. Electron temperature sufficient for DT beam driven fusion $T = \sim 4$ keV has been demonstrated in numerous experiments
3. Non-inductive current drive has been demonstrated in conventional tokamaks
4. Reduction of technical requirements on neutron loading in PHP to 0.2 MW/m² and fluence value for operation time below 2 MWa/m² allows to use commercially available materials
5. Economics of PHP is acceptable in case of total products sale : MA incineration, electricity production, tritium, fuel breeding for U-Pu and Th-U nuclear fuel cycles.
6. Russia has an appropriate cooperation of fusion and fission organizations and well qualified staff
7. System models and codes predict appropriate parameters of PHP
8. Structural materials developed for nuclear reactors are available with appropriate lifetime in neutron environment and property recycling after irradiation

Major facilities on the path to Industrial Hybrid Plant

Russian Tokamaks

Technology Test beds

DEMO-FNS as test bed for fusion and fission technologies

Steady State Technologies

DT neutrons

MS blankets

1. Magnetic system
2. Vacuum chamber
3. Divertor
4. Blanket
5. Remote handling
6. Heating and current drive
7. Fuelling and pumping
8. Diagnostics
9. Safety
10. Molten salts

1. Integration

1. Materials

2. Components

2. Licensing

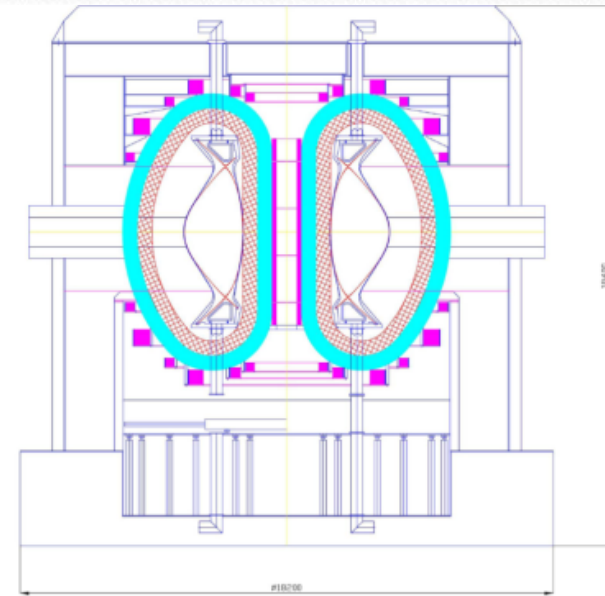

1. Hybrid Technologies

Pilot Hybrid Plant construction by 2030

$P=500 \text{ MWt}, Q_{\text{eng}} \sim 1$

Industrial Hybrid Plant construction by 2040

$P=3 \text{ GWt}, Q_{\text{eng}} \sim 6.5, P=1.3 \text{ GWe}, P=1.1 \text{ GW}(\text{net}), \text{MA}=1\text{t/a}, \text{FN}=1.1 \text{ t/a}$

Pilot Hybrid Plant (2030)

R, m	2.5
R/a	2.5
κ	2.1
δ	0.5
I_p, MA	5.0
B_T, T	5.0
$n, 10^{20}m^{-3}$	1.0
$P_{ntn}/S, MW/m^2$	0.2
E_b, keV	500
P_b, MW	30
Angle of NBI, degree	0
P_{EC}, MW	6
H-factor	1.2
β_N	<3
$f_{non-ind}$	1.0
P_{diss}, TF, MW	15.0
P_{diss}, PF, MW	5.0
S_{wall}, m^2	160
V_{pl}, m^3	50

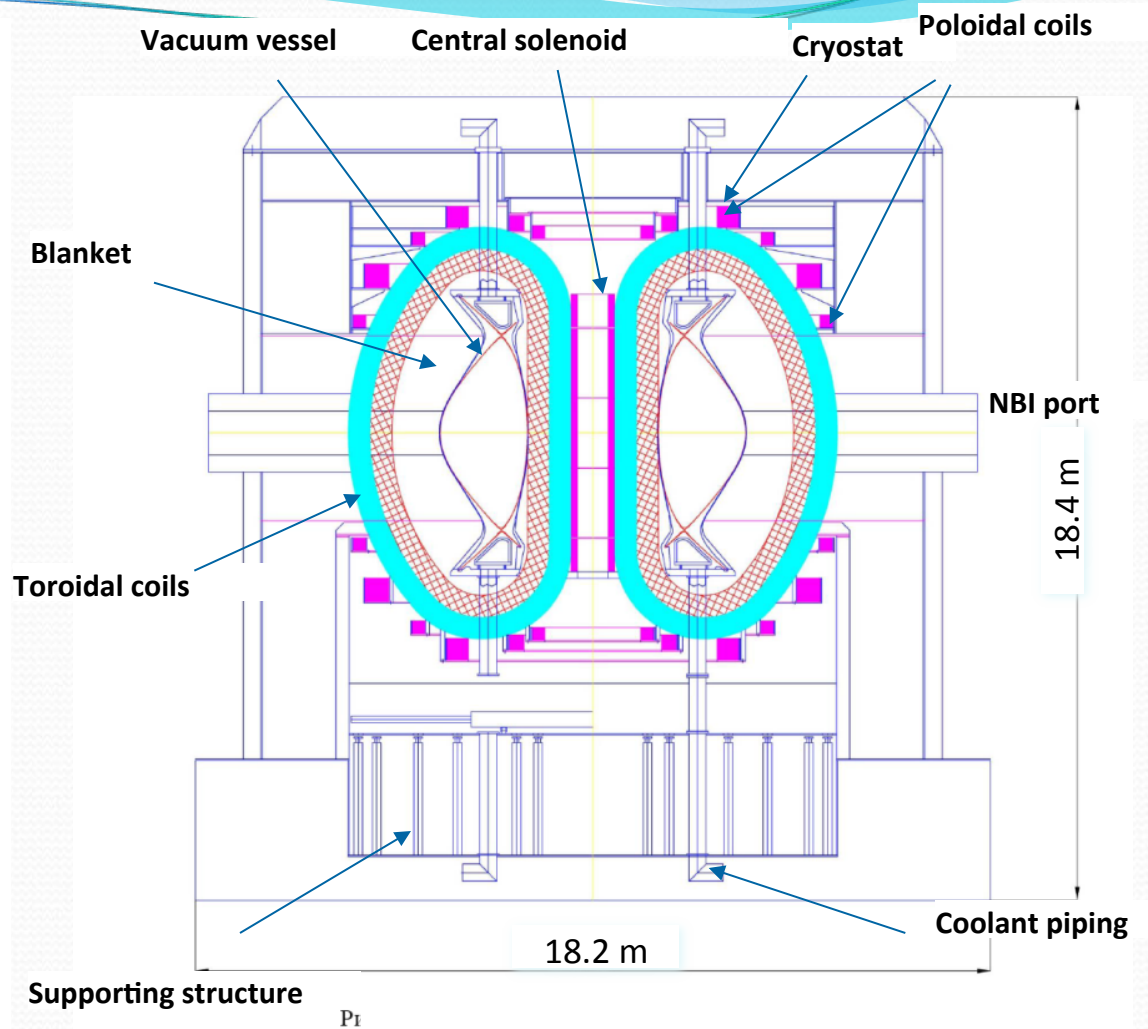

Fissile isotope and tritium breeding, incineration of long life radiotoxicity, electricity production, molten salt technologies for nuclear fuel cycle

Schematic diagrams of hybrid blankets

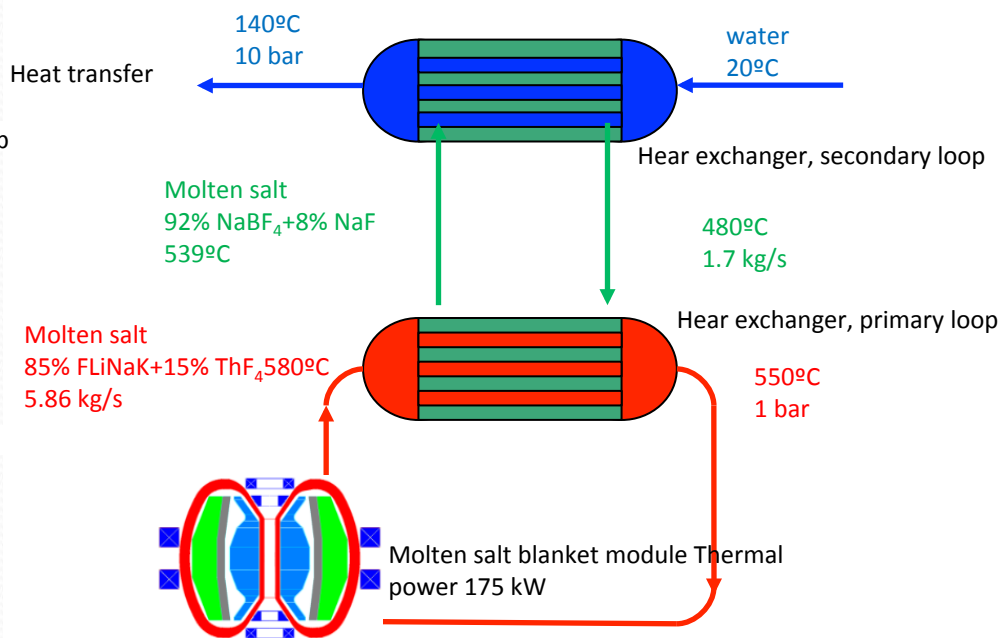
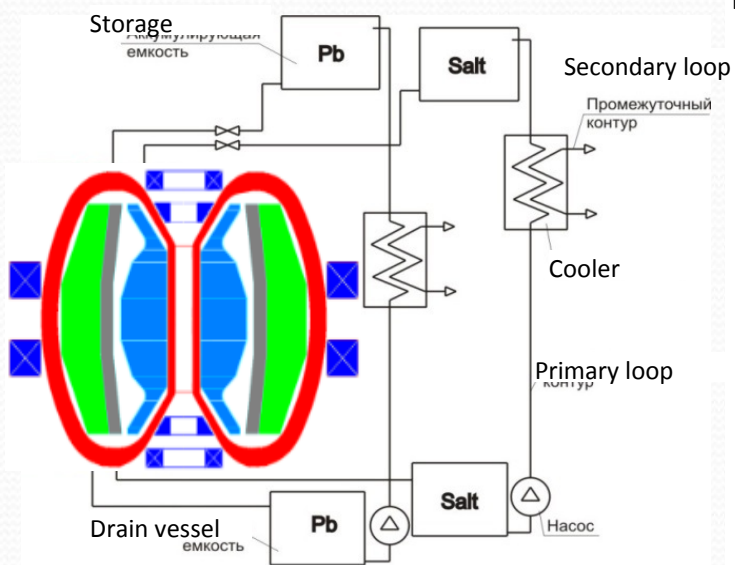



The conception of the radioactivity reduction during process production fuel from raw isotopes by the capture of fusion neutrons of U238 and Th232 in molten salt blanket located around tokamak.

The construction of molten salt circuit channel allows continuously remove from neutron flux Pu239 and U233 together with small number of fission products.

In comparison with fission breeder the fuel production in hybrid number fissions very minimized will this provides the radioactivity reduction losses more than order. Also the energy output will reduce by order during of the fuel production.

Neutron generation and Energy balance for new fissile isotopes production

for Hybrid and fast breeder

Pu239 from U-238

Capture	Fission
3.35	0.6467

U-233 from Th-232

Capture	Fission
1.73	0.14

Energy released per one fissile isotope

43 MeV

25 MeV

In fast reactor for produce one fissile isotope > 500 MeW energy is released

Fuel cycle with low radioactivity

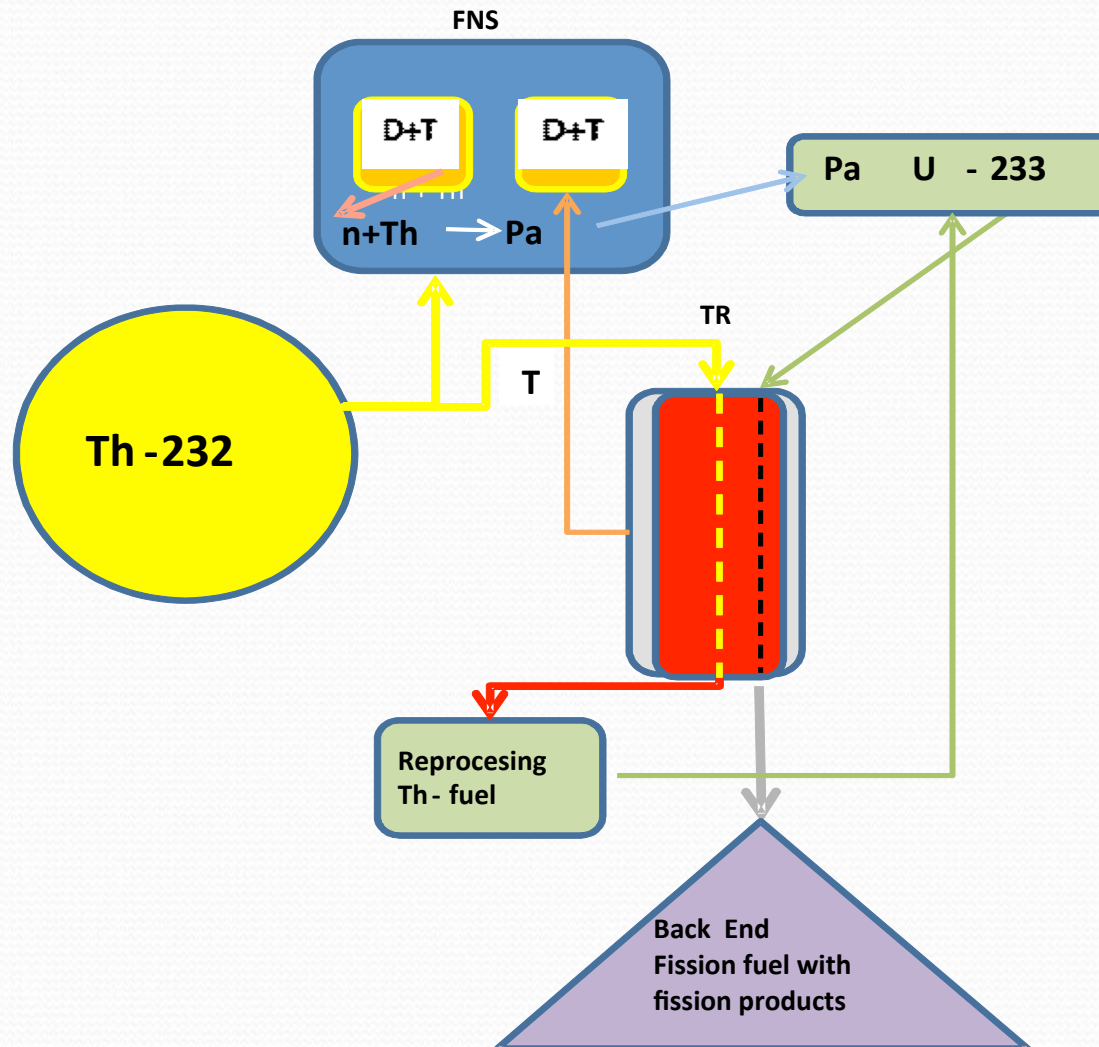

Reduction of the radioactivity for nuclear fuel cycle loss

Hybrid reactors with a molten salt blanket resolve the actual task of reducing the impact of Nuclear Energy fuel cycle on environment

Modeling shows that fission rate in hybrid blanket for fuel isotope breeding is substantially less than in fast reactors, which reduces the activity of processing loss more than an order of magnitude

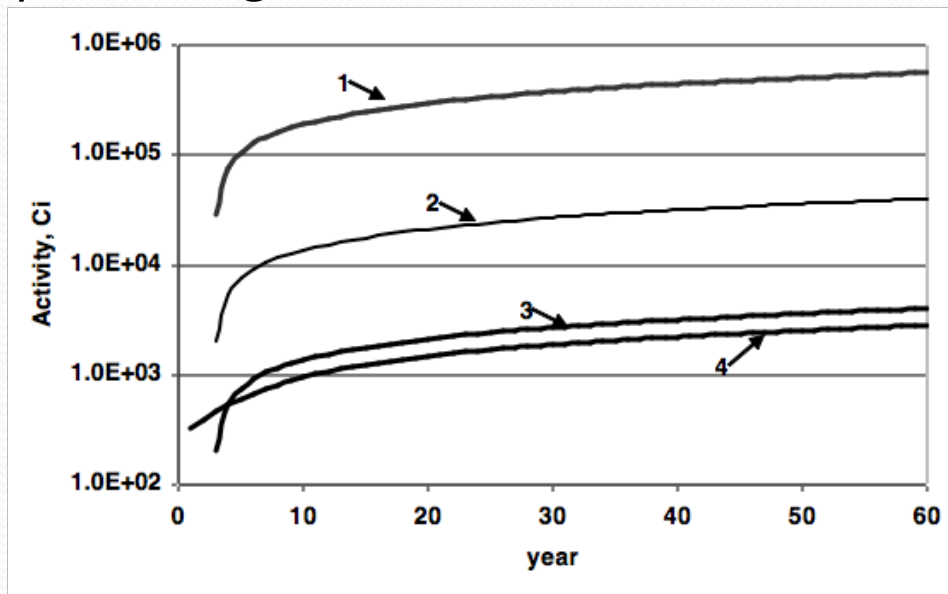

Growth of activity for 0.1% loss

- 1 – fast reactor with breeding factor ~ 1
- 2 – fast reactor with breeding factor ~ 1.4
- 3 – hybrid reactor
- 4 – modern fission power plants with VVER

SCHEME OF STRUCTURE AND PROPERTIES RESTORATION OF BLANKET MATERIALS IN HYBRIDS USING RECOVERY ANNEALING

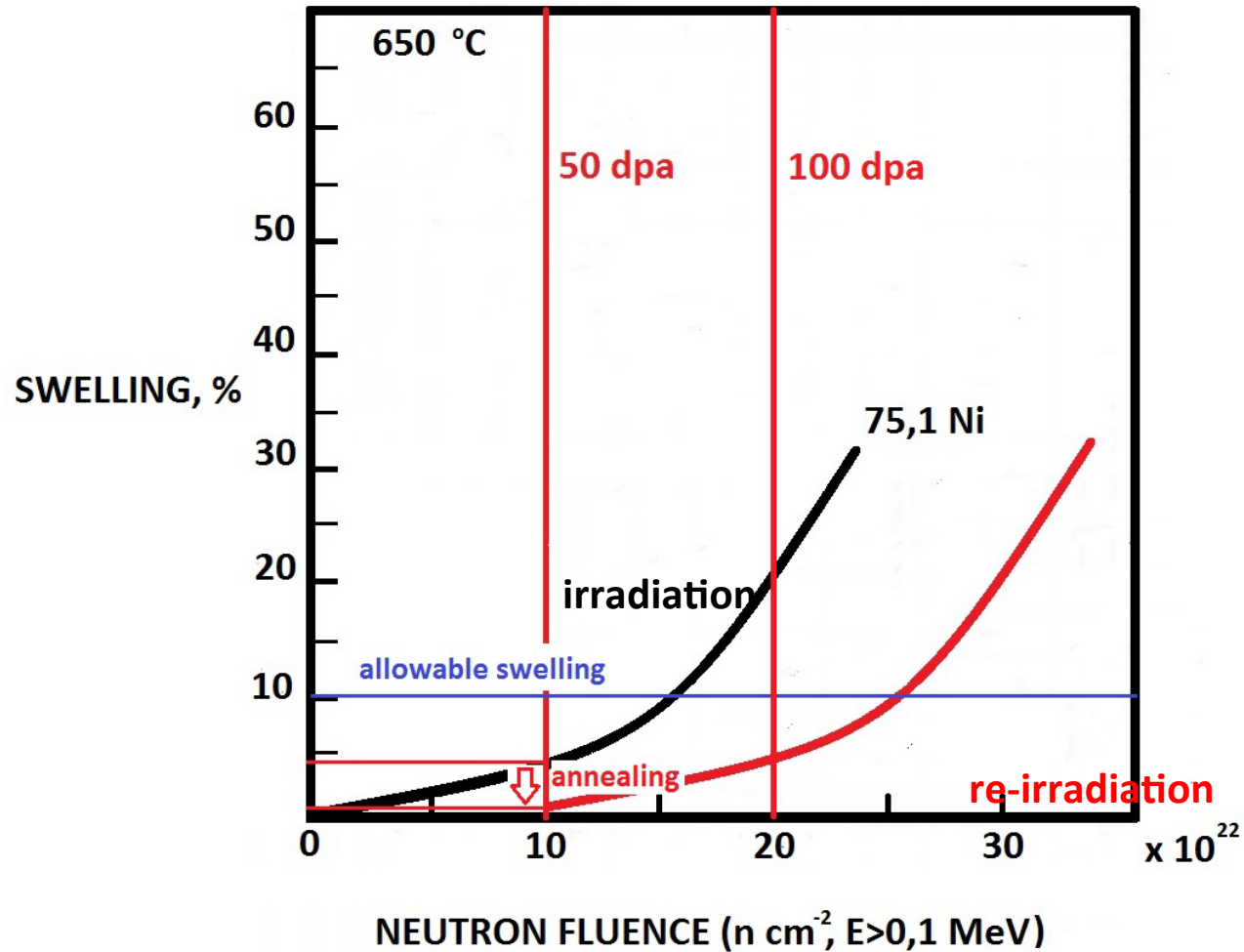

The technology developed of recovery annealing, that restores the properties of blanket structural materials, allows us to make the hybrid reactor life time higher

Recovery annealing of materials for lifetime extension of nuclear facilities

The use of annealing the reactor pressure vessel (RPV) made of heat-resistant steels leads to the restoration of mechanical properties to initial values due to recovery of the structural state and dissolution of grain boundary segregation of impurities formed under irradiation.

Recovery annealing was performed for 15 VVER-440 RPV that provided their lifetime extension for another resource.

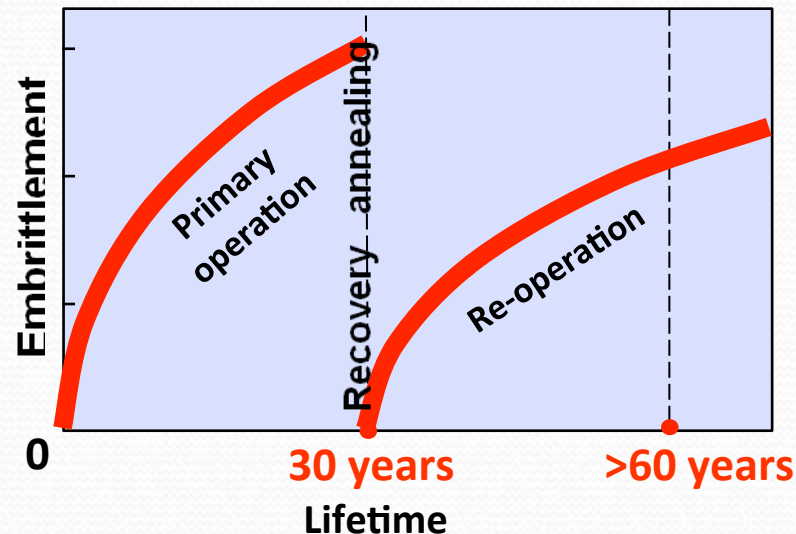

Now the regime and technology of recovery annealing are developed for VVER-1000 RPV. It doubles the lifetime of operating VVER-1000 reactors and avoids commissioning of additional units.

A similar approach can be used to extend the lifetime of VVER-1000 internals made of stainless steel and can also be considered for blanket materials of future fusion facilities

Conclusions

- Fusion-Fission Hybrids based on tokamak concept and molten salt nuclear technologies open new opportunities for Nuclear Energy in 21-st century to resolve challenges of controlled fusion, limited resources of fissile isotopes and radiotoxicity generation
- Physics and engineering data bases on fusion and fission technologies, structural and functional materials are sufficient for design of demonstration hybrid facilities
- Reseach and Development Program aimed at creation of demonstration hybrid facility DEMO-FNS and pilot hybrid plant PHP has been proposed in Russia
- The Pilot Hybrid Reactor project together with ITER project are capable to become basis for construction of the first Commercial Fusion Power Plant (CFPP) in Russia by 2050